

218
218/S

218/TF
218/S-TF

218/TF-FEP
218/S-TF-FEP

HALOGENNIEDERVOLTFASSUNG

LAMP HOLDERS FOR EXTRA LOW VOLTAGE TUNGSTEN HALOGEN INCANDESCENT LAMPS

Technische Daten

Technical data

- LAMPENSOCKEL - Lamp cap	G4 GY4 G5.3 GX5.3 GX6.35 GZ6.35
- Nennstrom und Nennspannung - Rated current and voltage	10A-24V
- Maximale Betriebstemperatur (IEC) - Maximum operating temperature (IEC)	T350
- Schutzgrad - Protection index	IP20
- Überspannungskategorie - Impulse withstand category	II





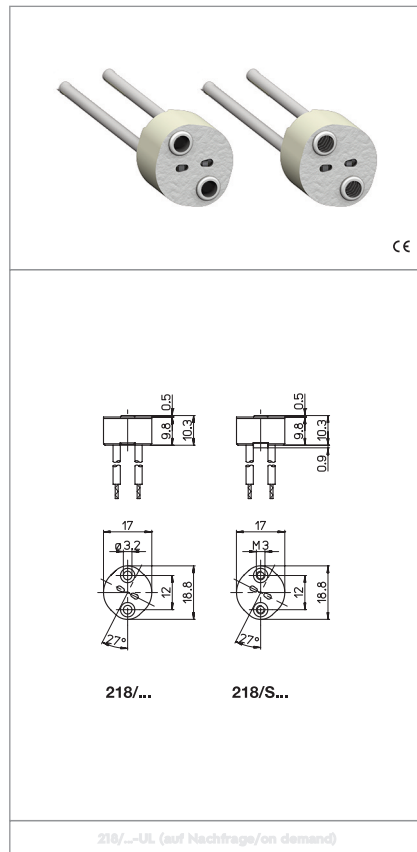

Merkmale

Characteristics

.../S= mit M3 Schraubbuchsen
.../S= with M3 threaded bushes

- Steatit Gehäuse
– Steatite body
- Nickel Kontakt
– Nickel contacts
- Glimmer Platte / Abdeckung
– Mica cover



 Schraubbefestigung screw fixing	 an leitung punktgeschweisster Kontakt conductor electrically spot-welded to the contact	 mm ² Bereich mehradrige Leitungen mit Aderendhülsen section of the flexible conductor with ferrule SIL 1	 mm ² Bereich mehradrige Leitungen mit Aderendhülsen section of the flexible conductor with ferrule TF 1
 mm ² Bereich mehradrige Leitungen mit Aderendhülsen section of the flexible conductor with ferrule FEP 1	 12 cm Leitungslänge flexibel flexible wire length		

Prüfzeichen

Quality marks

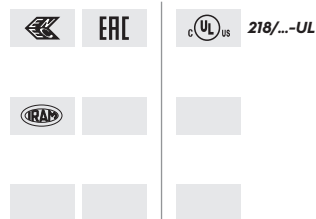

Europäische Richtlinien

European directives

gemäß "RoHS"
"RoHS" compliant
unterliegt nicht "WEEE"
Not subject to "WEEE"

Gewichte und Verpackung

Weights and packaging

Artikel/Art. Produktinweise Product references	g Nettogewicht Net weight	n° pz pro Beutel per bag	n° pz pro Box per box	n° pz pro Karton per carton
218	9,2		200	
218/TF	8,6		200	
218/TF-FEP	8,3		200	
218/S	10,2		200	
218/S-TF	9,5		200	
218/S-TF-FEP	9,3		200	

Bemerkung

Notes

Bemerkung

Note

ARTIKEL AUS STEATIT

Produkte, die aus Steatit formgespritzt sind, durchlaufen dimensionale Veränderungen bei durch Austrocknung bei hohen Temperaturen. Daher ist ein Hinweis auf die in DIN40680 angegebenen Toleranzen anzugeben, Mittelwert bezogen auf die Nennwerte gemäß Angabe im Katalog.

ARTICLES IN STEATITE

Products moulded in steatite undergo dimensional changes during the high temperature curing process. Therefore reference must be made to the tolerance stated in DIN 40680, middle values referred to the nominal values stated in the catalogue.

ABMESSUNGEN DIMENSIONS	Toleranzen/Tolerance
	DIN40680
Fino a/Up to 4	±0,15
Von/From 4,1 bis/to 6	±0,20
Von/From 6,1 bis/to 8	±0,25
Von/From 8,1 bis/to 10	±0,30
Von/From 10,1 bis/to 13	±0,35
Von/From 13,1 bis/to 16	±0,40
Von/From 16,1 bis/to 20	±0,45
Von/From 20,1 bis/to 25	±0,50
Von/From 25,1 bis/to 30	±0,55
Von/From 30,1 bis/to 35	±0,60
Von/From 35,1 bis/to 40	±0,65
Von/From 40,1 bis/to 45	±0,70
Von/From 45,1 bis/to 50	±0,80
Von/From 50,1 bis/to 55	±0,90
Von/From 55,1 bis/to 60	±1,00